



KAON Set-Top Box & Remote

KSTB2020

User/Installation Guide



TABLE OF CONTENTS

WHAT'S IN THE BOX?	1
SET-TOP BOX AT A GLANCE	2
REMOTE CONTROL FUNCTIONALITY	4
KURV 1.0 SEARCH REMOTE	8
KURV 2.0 VOICE REMOTE	12
KURV 1.0 / KURV 2.0 REMOTE OK BUTTON FUNCTIONALITY	16
KURV 1.0 / KURV 2.0 REMOTE GOOGLE ASSISTANT BEHAVIOR	17
KURV 1.0 / KURV 2.0 REMOTE BATTERY INSTALLATION	18
SELF-INSTALL PHYSICAL PLACEMENT GUIDELINES	19
USAGE CONSTRAINTS	19
SELF-INSTALL INSTALLATION GUIDELINES	20
INITIAL BOX POWER ON	24
NETWORK SETUP	30
SERVICE VALIDATION	31
TROUBLESHOOTING	32
APPENDIX A: TV CODES FOR REMOTE PAIRING	33
APPENDIX B: AUDIO SYSTEM CODES FOR REMOTE PAIRING	43



© Blonder Tongue Laboratories, Inc., ISO 9001:2015 Certified. All rights reserved, specifications are subject to change without notice.



The terms HDMI and HDMI High-Definition Multimedia Interface, and the HDMI Logo are trademarks or registered trademarks of HDMI Licensing Administrator, Inc. in the United States and other countries.



Manufactured under license from Dolby Laboratories. Dolby, Dolby Audio, and the double-D symbol are trademarks of Dolby Laboratories.

WHAT'S IN THE BOX?



**KSTB2020
Set-Top Box
(STB)**



HDMI Cable



KURV Remote
*KURV 2.0 Voice
Remote Control
Shown*



AA Batteries



Power Adapter



**RCA Analog
Composite
Breakout Cable
(Optional)**

SET-TOP BOX AT A GLANCE

Top View



- 1 Power Button:**
Used to power the Kaon STB On or Off.

Front View



- 2 Status Indicator LED:**
Indicates power status of STB (Red = Off, Green = On).
- 3 Infrared (IR) Sensor:**
Used to communicate with the KURV Remote Control.

Rear View

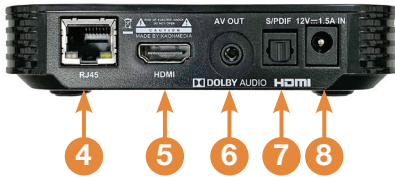

- 4 RJ45:**
10/100 Ethernet port used to connect to a home router.
- 5 HDMI:**
Digital A/V output, used to connect to a TV via HDMI cable.
- 6 AV Out:**
SD Analog A/V output, used to connect to older-style TVs that do not support HDMI connections. Ask your installer for an RCA composite breakout cable if one was not included.
- 7 S/PDIF:**
Optical Audio output, used to connect to external Sound bar or Surround Sound system. An optical cable with TOSLINK connectors is required (not included).
- 8 12V/1.5A In:**
DC Power port, used to connect via the power adapter.

Side View



- 9 USB:**
This port has an output power capability of 5V DC @ 1 amp.

REMOTE CONTROL FUNCTIONALITY

Backlighting

The remote control is a motion detecting device and will backlight when the remote is picked up or moved.

Backlighting will remain on for 3 seconds.

Hot Keys



*KURV 2.0 Voice
Remote Control Shown*

Hot Keys

The following Hot Keys are dedicated short cuts to return the user to the video service regardless of the content or App being viewed.



- 1 MENU:**
Displays the Main Menu.
- 2 LAST:**
Displays the last 15 items that have been watched.
- 3 HOME:**
Displays the main Android TV menu including access to Apps.
- 4 GUIDE:**
Displays the Electronic Program Guide (EPG).
- 5 SHOWS:**
Displays the shows that are presently available for viewing On Demand (VOD).
- 6 MOVIES:**
Displays the movies that are presently available for viewing On Demand (VOD).

Button Functionality



KURV 2.0 Voice
Remote Control Shown

- 1 TV POWER:**
Powers on or off TV if remote is programmed with a TV infrared code.
- 2 TV INPUT:**
Changes video input on TV if remote is programmed with a TV infrared code.
- 3 POWER:**
Switches STB power on or into standby or off mode. Will also control TV power and audio system after remote has been programmed with a TV/Audio Infrared code.
- 4 PAGE (Up or Down):**
In the GUIDE or MENU screens, scrolls one page up or down.
- 5 MENU:**
Launches the MAIN MENU within the App with Live Video or last viewed On-Demand program.
- 6 LIVE TV:**
Tunes to the last content viewed in the App.
- 7 MUTE:**
Mutes the audio on your audio device(s) (TV, Audio System, or STB).
- 8 VOLUME (Up or Down):**
Increases or decreases volume levels on your audio device(s).
- 9 CHANNEL (Up or Down):**
Selects the previous and next available channels. (Hold for rapid advance.) Within MENU or GUIDE acts the same as Page Up/Page Down.

- 10 GOOGLE HOME:**
 Launches AndroidTV main menu including access to Apps.
- 11 LAST:**
 Displays the last 15 items that have been watched.
- 12 BACK / EXIT:**
 Returns to previous menu or state within current App. From live video, this key opens the Main Menu.
- 13 GUIDE:**
 Launches the Channel GUIDE (EPG) within the App.
- 14 ARROWS:**
 Moves to highlight items in respective direction.
- 15 OK / SELECT:**
Short Press - Confirms a selection. When watching video in the App, info on the current video playing appears, including the time shift bar.
Long Press - Invokes the App search menu. This is the same function as the magnifying glass in the Main Menu.
- 16 SHOWS:**
 Launches the SHOWS play list in the App.
- 17 MOVIES:**
 Launches the MOVIES play list in the App.
- 18 SEARCH / VOICE:**
 Launches text-based Google Assistant search.  Launches voice-based Google Assistant search.
- 19 RECORD:**
 Begin recording selected content in the App.
- 20 REWIND:**
 Fast rewinds VOD, or live TV.
- 21 FAST FORWARD:**
 Fast forwards VOD, or live TV.
- 22 PAUSE / PLAY:**
 Play or Pause toggle of VOD, or live TV.
- 23 0-9:**
 Enters channel numbers in the GUIDE or full screen video.
- 24 SET:**
 Setup the remote to control the TV, and to program an audio device with Infrared (IR) commands.

KURV 1.0 SEARCH REMOTE



Remote Pairing Operation

STB / Remote IR – RF Mode Conversion

For customers who wish to place the STB in a non-line of sight position (with respect to the remote control) the remote must operate in RF mode. As the remote operates in IR mode by default the user will have to convert the remote operation from IR mode to RF mode by the following sequence:

- While in the same room with the STB, press and hold **Set** on the remote for approximately 3 seconds. The remote LED will initially display red.
- After 3 seconds the remote LED will turn green. Immediately press the home button ().
- A 3-digit code will be displayed on the TV screen.
- Enter the 3-digit code shown on the TV.
- If successful, “Connected” will be displayed on the TV screen and the remote now operates via RF mode.

If “Connected” is not displayed, wait 3 minutes, then try the above procedure again.

Once successfully paired (Connected), the STB may be placed in a non-line of sight location such as behind the TV or in a cabinet.

To return the remote to the line of sight IR mode of operation, perform the following steps:

- On the remote press and hold **Set** for 3 seconds, until the LED turns green.
- On the remote Press **9 8 1**.
- Successful completion is signaled by 2 green blinks.

If the remote at any time fails to pair, or is not functioning properly, factory reset the remote using the **Set 9 8 1** sequence above, then re-pair remote.

TV / Remote Programming

Prior to programming remote control to control volume on TV/Power Bar, ensure that volume on those devices is fully turned up. This will yield the widest audio dynamic range when remote is used to control volume on those devices.

By default, the remote controls the Volume and Power on the STB. To program the remote to the TV, such that remote Master Power key presses adjust Power and Volume on the TV by Infrared commands directly follow the instructions below:

- Press and hold the **Set** key until the remote LED turns green.
- Enter the 5-digit code as shown in **Appendix A**.
- Successful programming is indicated by two green blinks of the LED.
- Unsuccessful programming is indicated by two red blinks of the LED.

Ecosystem Setup Recommended for the Correct Audio Behavior

It is **strongly** recommended to program the KURV remote to allow the TV or Audio System control the sound. This will ensure that any channels encoded with Dolby Surround operate as expected. If the STB is allowed to control the sound, channels encoded with Dolby Surround may render with no audio.



Programming codes for TV's and Audio Systems are found in Appendices A and B.

NOTE: When entering TV programming codes, ensure the code used has the ability to control both Power and Sound. Some codes may control Power alone and some Audio alone. Use the code that controls both Power and Sound to process Dolby Surround as expected. When the TV code has been programmed, confirm the volume key on the remote brings up the TV sound level indicator, not the STB sound level indicator.

It is also **strongly** recommended that any TV sound leveling technology be disabled. This technology is generally used to squelch advertisement audio that is increased intentionally. This technology may cause unintended variations in sound levels.

TV Code Auto-Search Method

If a code cannot be located in Appendix A or B, use this method to find control programming:

- Press and hold the **Set** key for 3 seconds, until the LED turns green.
- On the remote Press **9 9 1**.
- Press the **CH**  sequentially until the TV turns off.
- Press the **OK / SELECT**  key to enter this control into the remote.
- Successful programming is indicated by two green blinks of the LED.

Volume and Mute Controlling Device Link

By default, the remote controls the Volume and Mute on the STB. To program the remote to control Volume and Mute on the TV follow the instructions below:

- Press and hold the **Set** key until the remote LED turns green.
- Press the **VOL**  key.
- Successful programming is indicated by two green blinks of the LED.
- Unsuccessful programming is indicated by two red blinks of the LED.

To return remote to default for Volume and Mute control on the STB, follow the instructions below:

- Press and hold the **Set** key until the remote LED turns green.
- Press the **VOL**  key.
- Successful programming is indicated by two green blinks of the LED.
- Unsuccessful programming is indicated by two red blinks of the LED.

Remote Behavior



If the remote has been programmed to the TV as described on the previous page, the Remote's TV power button () will control the TV power only.

This will not affect the powered state of the STB. The "all devices" power button () will control the TV power as well as the STB power states if remote has been fully programmed with TV and Audio system.

The "all devices" power button () may be used in two ways while system is fully powered on:

Short Press: Will turn off TV and put the STB into a standby mode.

Long Press: User will be prompted if they want STB to be powered down (non-standby) mode. If OK is selected, the TV and STB will all be powered down. The STB will be fully powered down and not be in standby mode.

NOTE: To prevent the STB and the "all devices" power button () user input reactions from becoming unsynchronized (i.e. the "all devices" power button () turns the TV Off while turning the STB On, or vice versa) it is recommended to use only Short Presses of the "all devices" power button () .

If a Long Press of the "all devices" power button is used to Power Off the TV, it **MUST** be followed by a Long press to turn the TV back On. If a Long Press to turn the TV Off is followed by a Short Press to turn TV On, the TV and STB may become unsynchronized with the respect to being On or Off at the same time.

If the TV and STB become unsynchronized with respect to power button presses, power cycle (i.e. Remove power) to the STB, while the TV is On. This will re-synchronize the TV and STB power.

KURV 2.0 VOICE REMOTE



Remote Pairing Operation

STB / Remote IR – RF Mode Conversion

For customers who wish to place the STB in a non-line of sight position (with respect to the remote control) the remote must operate in RF mode. As the remote operates in IR mode by default the user will have to convert the remote operation from IR mode to RF mode by the following sequence:

- While in the same room with the STB, press and hold **Set** on the remote for approximately 3 seconds. The remote LED will initially display red.
- After 3 seconds the remote LED will turn green. Immediately press the home button ().
- A 3-digit code will be displayed on the TV screen.
- Enter the 3-digit code shown on the TV.
- If successful, “Connected” will be displayed on the TV screen and the remote now operates via RF mode.

If “Connected” is not displayed, wait 3 minutes, then try the above procedure again.

Once successfully paired (Connected), the STB may be placed in a non-line of sight location such as behind the TV or in a cabinet.

To return the remote to the line of sight IR mode of operation, perform the following steps:

- On the remote press and hold **Set** for 3 seconds, until the LED turns green.
- On the remote Press **9 8 1**.
- Successful completion is signaled by 2 green blinks.

NOTE: The remote must be in RF Paired (Bluetooth) mode for remote Voice functionality to work correctly. If the remote at any time fails to pair, or is not functioning properly, factory reset the remote using the **Set 9 8 1** sequence above, then re-pair remote.

TV / Remote Programming

Prior to programming remote control to control volume on TV/Power Bar, ensure that volume on those devices is fully turned up. This will yield the widest audio dynamic range when remote is used to control volume on those devices.

By default, the remote controls the Volume on TV, and Power on the STB. To program the remote to the TV, such that remote Master Power key presses adjust Power and Volume on the TV by Infrared commands directly follow the instructions below:

- Press and hold the **Set** key until the remote LED turns green.
- Enter the 5-digit code as shown in **Appendix A**.
- Successful programming is indicated by two green blinks of the LED.
- Unsuccessful programming is indicated by two red blinks of the LED.

Audio System - Sound Bar / Remote Programming

Prior to programming remote control to control volume on TV/Power Bar, ensure that volume on those devices is fully turned up. This will yield the widest audio dynamic range when remote is used to control volume on those devices.

By default, the remote controls the Volume on TV, and Power on the STB. To program the remote to the Sound Bar, such that remote Master Power key presses adjust Volume on the Sound Bar by Infrared commands directly, follow the instructions below:

- Press and hold the **Set** key until the remote LED turns green.
- Enter the 5-digit code as shown in **Appendix B**.
- Successful programming is indicated by two green blinks of the LED.
- Unsuccessful programming is indicated by two red blinks of the LED.

Ecosystem Setup Recommended for the Correct Audio Behavior



It is **strongly** recommended to program the KURV remote to allow the TV or Audio System control the sound. This will ensure that any channels encoded with Dolby Surround operate as expected. If the STB is allowed to control the sound, channels encoded with Dolby Surround may render with no audio. Programming codes for TV's and Sound Bars/Systems are found in Appendices A and B.

NOTE: When entering TV programming codes, ensure the code used has the ability to control both Power and Sound. Some codes may control Power alone and some Audio alone. Use the code that controls both Power and Sound to process Dolby Surround as expected. When the TV code has been programmed, confirm the volume key on the remote brings up the TV sound level indicator, NOT the STB sound level indicator.

It is also **strongly** recommended that any TV sound leveling technology be disabled. This technology is generally used to squelch advertisement audio that is increased intentionally. This technology may cause unintended variations in sound levels. **13**

TV Code Auto-Search Method

If a code is not in Appendix A or B, use this method to find control programming:

- Press and hold the **Set** key for 3 seconds, until the LED turns green.
- On the remote Press **9 9 1** .
- Press the **CH**  sequentially until the TV turns off.
- Press the **OK / SELECT**  key to enter this control into the remote.
- Successful programming is indicated by two green blinks of the LED.

Volume and Mute Controlling Device Link

By default, the remote controls the Volume & Mute on the TV or Sound Bar. To program the remote to control Volume and Mute on the STB, such that remote can adjust volume on the Sound Bar by Infrared commands directly, follow these instructions:

- Press and hold the **Set** until the remote LED turns green.
- Press the **VOL**  key.
- Successful programming is indicated by two green blinks of the LED.
- Unsuccessful programming is indicated by two red blinks of the LED.

To return remote to default for Volume and Mute control on the TV or Sound Bar, follow the instructions below:

- Press and hold the **Set** key until the remote LED turns green.
- Press the **VOL**  key.
- Successful programming is indicated by two green blinks of the LED.
- Unsuccessful programming is indicated by two red blinks of the LED.

Remote Behavior



If the remote has been programmed to the TV and Audio Systems as described on the previous page, the remote's TV power button () will control the TV power only.

This will not affect the powered state of the STB. The "all devices" power button () will control the TV power as well as the STB and audio system power states if remote has been fully programmed with TV and Audio system.

The "all devices" power button () may be used in two ways while system is fully powered on:

Short Press: Will turn off TV / Audio System and put the STB into standby mode.

Long Press: User will be prompted if they want STB to be powered down (non-standby) mode. If **OK** is selected, the TV, Audio system, and STB will all be powered down. The STB will be fully powered down and not be in standby mode.

NOTE: To prevent the STB and the "all devices" power button () user input reactions from becoming unsynchronized (i.e. the "all devices" power button () turns the TV Off while turning the STB On, or vice versa) it is recommended to use only Short Presses of the "all devices" power button () .

If a Long Press of the "all devices" power button is used to Power Off the TV, it **MUST** be followed by a Long press to turn the TV back On. If a Long Press to turn the TV Off is followed by a Short Press to turn TV On, the TV and STB may become unsynchronized with the respect to being On or Off at the same time.

If the TV and STB become unsynchronized with respect to power button presses, power cycle (i.e. Remove power) to the STB, while the TV is On. This will re-synchronize the TV and STB power.

KURV 1.0 / KURV 2.0 REMOTE OK BUTTON FUNCTIONALITY



When pressing the **OK/Select** key for an extended time, on either the **KURV 1.0** or **KURV 2.0** remote controls, the Operator in app search screen appears on the TV.

The **KURV 1.0 SEARCH** remote control is only capable of a manual text search using the keyboard. Arrow right to the Search Box and press OK to display the on-screen keyboard to type out a search string.

The **KURV 2.0 VOICE** remote control is capable of searching by talking into the remote. When activated, speak into the remote.

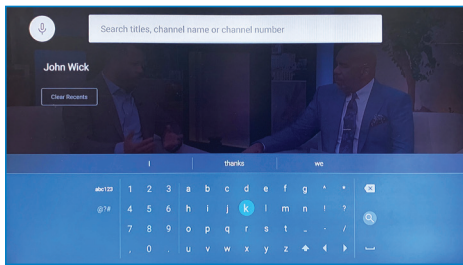

KURV 1.0 SEARCH SCREEN

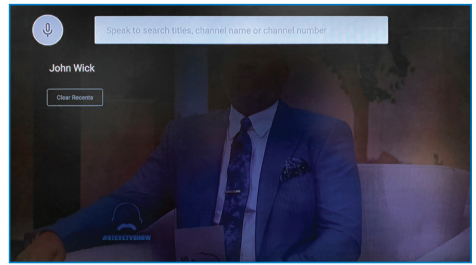

KURV 2.0 SEARCH SCREEN

Once **Search** has been selected by a *long press and release* of **OK** button, the search window will appear, allowing the user to type in (or speak) search keywords for content titles (series, movies, episodes) and channel titles across live, upcoming, lookback and VOD content within the Operator App.

When using a **KURV 2.0 VOICE** enabled remote for in App searching, ensure that the on screen microphone is highlighted. This signifies that voice input is enabled. If you are in the search screen and the voice microphone is not highlighted in red, a *short press of the OK button will enable the voice input*.

Once a search term has been typed or spoken, the results will be populated, and may contain results that fall into one or more of the following categories:

- Shows** (e.g. Type/Speak "Wheel of Fortune")
- Live & Upcoming** (e.g. Type/Speak "Tennis")
- Movies** (e.g. Type/Speak "Lost in Space")
- Episodes** (e.g. Type/Speak "The One Where Joey Tells Rachel")
- Channels** (e.g. Type/Speak "MSNBC")

The user may select any of the results in order to access additional information about the program.

Note: The channel search is not yet supported (e.g. "Tune to Channel 7" or "Tune to MSNBC")

KURV 1.0 / KURV 2.0 REMOTE GOOGLE ASSISTANT BEHAVIOR

When pressing the **Google Assistant** button on the remote, behavior is dependent upon whether the user is signed in or not to Google. Users signed in to Google will experience a broader interaction.

The **KURV 1.0 SEARCH** remote is only capable of manually entering text using the on-screen keyboard. The **KURV 2.0 VOICE** remote, when activated, is capable of listening to voice commands or manually entering text using the on-screen keyboard.

The following are **Google Assistant** examples that can be typed in or spoken:

YouTube

- “Open YouTube App”
- “Play Cat Videos on YouTube”
- “Search for Sitcoms on YouTube”
- “Tell Me Information about Game of Thrones”

Video Control, i.e. YouTube

- Playback* - “Pause” “Stop” “Resume”
- Volume* - “Louder” “Softer”
- Power - “Turn Off” (puts the STB in standby mode)

Internet Searches

- “Who won the 1962 World Series.”
- “What is the capital of North Dakota.”
- “Who won the Warriors game?”
- “What’s 20% of 80?”
- “What does “gregarious” mean?”
- “How do I say Nice To Meet You in French?”
- “How’s the S&P 500 doing?”
- “How many kilometers in a mile?”
- “Search for summer vacation ideas.”
- “Find pictures of kittens.
- “How do you remove red wine stains from a rug?”
- “Play some Jazz music.”
- “Play the latest episode from This American Life.”
- “What’s the latest news from BBC?”

To exit the Google assistant page press the back button .

* Google Sign-in is Required.

KURV 1.0 / KURV 2.0 REMOTE

BATTERY INSTALLATION

The remote requires two AA batteries.

Hold the remote with keys facing the floor. Battery cover is the entire back of the remote.



Using the ridges, slide the back cover towards the bottom of the remote, remove the cover and insert batteries in the direction shown.

Battery Monitoring

The remote has ability to output battery status. Follow the steps below to check Batteries:

- Press and hold the **Set** key until the remote LED turns green.
- On the remote Press **9 9 9** .
- If the Green LED blinks 4 times, battery status is excellent.
- If the Green LED blinks 3 times, battery status is good.
- If the Green LED blinks 2 times, battery status is low.
- If the Red LED blinks 1 time, battery status is very low and need to be replaced.

SELF-INSTALL PHYSICAL PLACEMENT GUIDELINES

The KSTB2020 set-top box should be placed in a location away from direct or indirect heat sources.

Remote Operating in IR Mode

With the remote operating in IR mode, it is recommended that the KSTB2020 be placed in sight for the end user. The IR sensor is in center of the front face plate.



Remote Operating in RF4CE Mode

With the remote operating in RF mode, the KSTB2020 may be placed out of sight. This may include behind a wall-mounted TV or in a TV cabinet.

USAGE CONSTRAINTS

External DVR via USB Drive

The USB port cannot be used to connect an external USB drive to support local DVR capability.

SELF-INSTALL CONNECTION GUIDELINES

HDMI Cable Connection

What You Need

- An HD or Ultra High Definition (UHD) TV that can support 720p, 1080p or 4K UHD.
- A Broadband Internet connection that supports a wired or WiFi wireless home network (802.11 g, n, or ac).
- Pay TV Operator login credentials (mandatory).
- Google login credentials (optional).

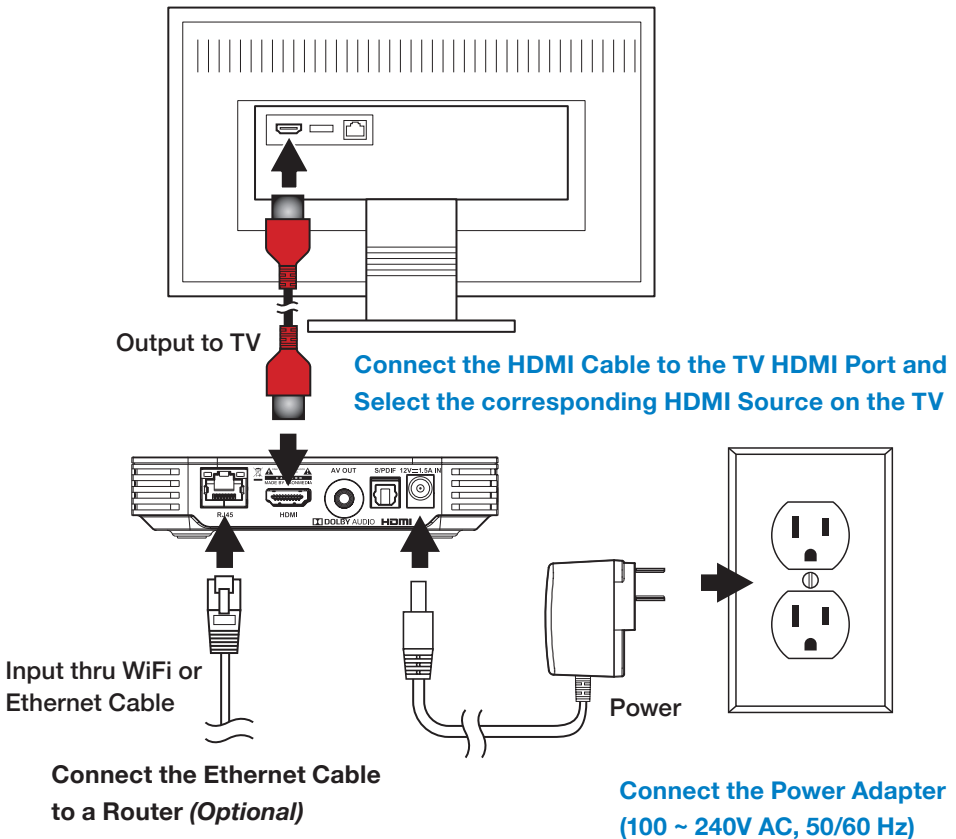

Analog Composite Breakout Cable Connection

Connect the analog composite cable as shown below. This connection scheme should only be used if the TV does not have a working HDMI port.

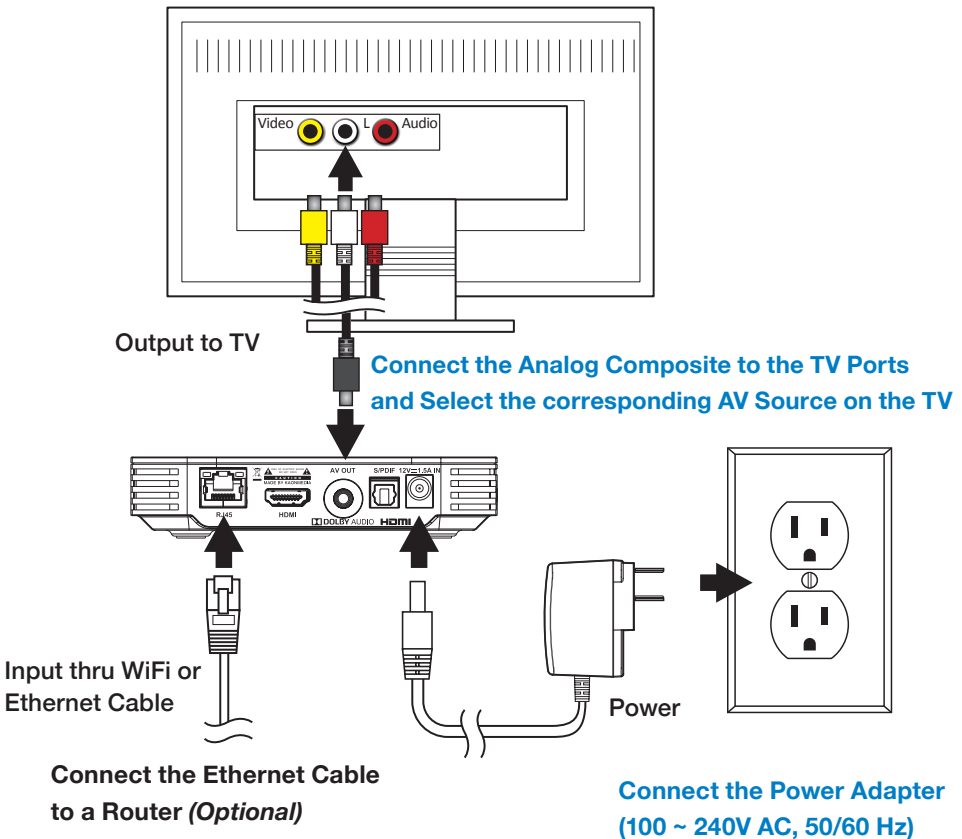

Network Connection

You must connect your new STB to an internet connection through either a WiFi wireless connection or a wired Ethernet connection.

Wired Network Connection

If your home router is near the STB location, a CAT-5/5e/6 Ethernet cable may be used for internet connectivity. Plug one end of the CAT-5/5e/6 cable into the STB RJ45 port. Plug the other end of the cable into any LAN port of your home router.

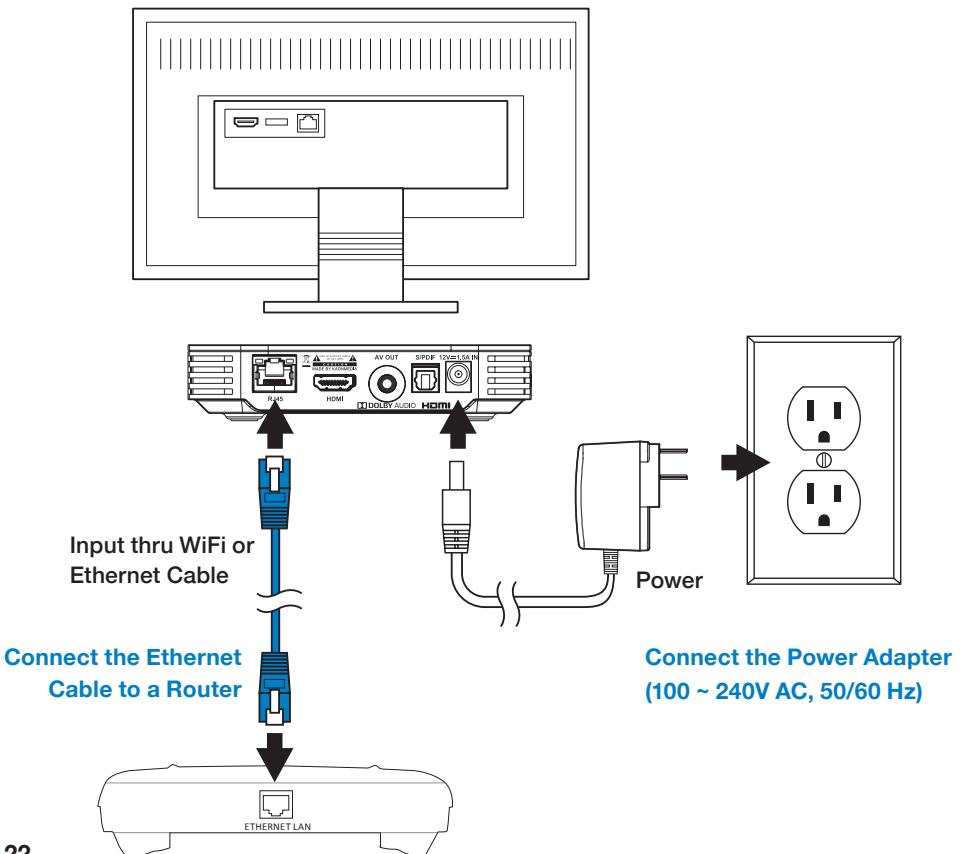

WiFi Network Connection

Connect Automatically Using WPS

Navigate to the Android main menu by pressing the following key sequences:

 Home →  Settings →  Network →  WiFi → Select to enable.

Once WiFi has been enabled, using the remote scroll down and select “Connect via WPS”.

Once selected press the WPS button on your home router. The Set-Top Box will automatically connect to the WiFi network.



Ensure that WiFi network signal strength is strong  or very strong .

Connect Manually

If your home WiFi router does not have a WPS button, you can connect manually. Navigate to the Android main menu by pressing the following key sequences:

 Home →  Settings →  Network →  WiFi → Select to enable.

Once WiFi has been enabled, using the remote scroll down and select the required network and press OK. When prompted, enter your WiFi password using the remote. Alternately a USB keyboard may be plugged into the USB port of the Set-Top Box. Type password on keyboard as required.

Ensure that WiFi network signal strength is strong  or very strong .

INITIAL BOX POWER ON

The following screens describe the remote key sequences required to setup the KSTB2020. When powered up and fully booted, the box will start on this screen.

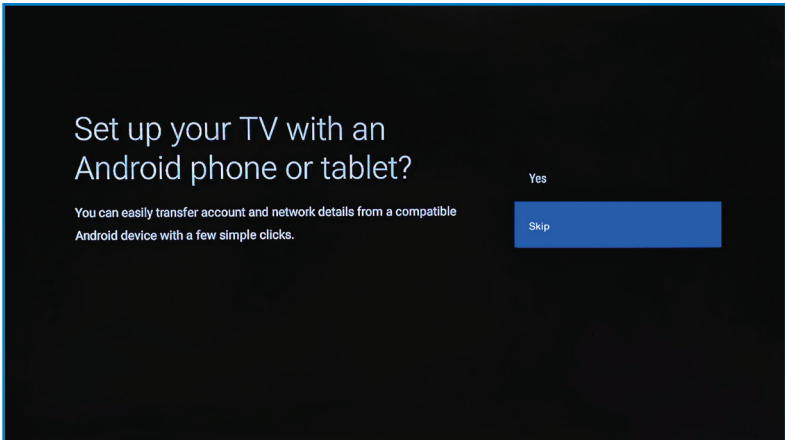

Select **Skip** and press **OK** to continue. The following screen will be displayed.

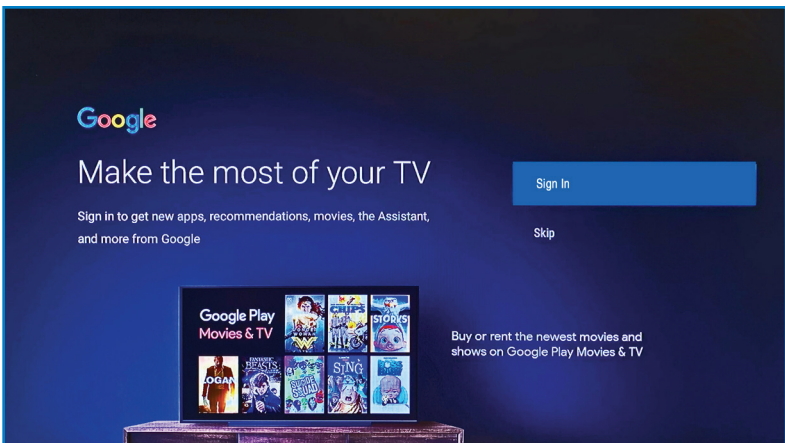

If the end user wishes to login with their Google ID they may do so at this point. If not, select **Skip** and press **OK** to continue.

Once logged in, the following Terms of Service screen will be displayed. Select **Accept** and press **OK** to continue.

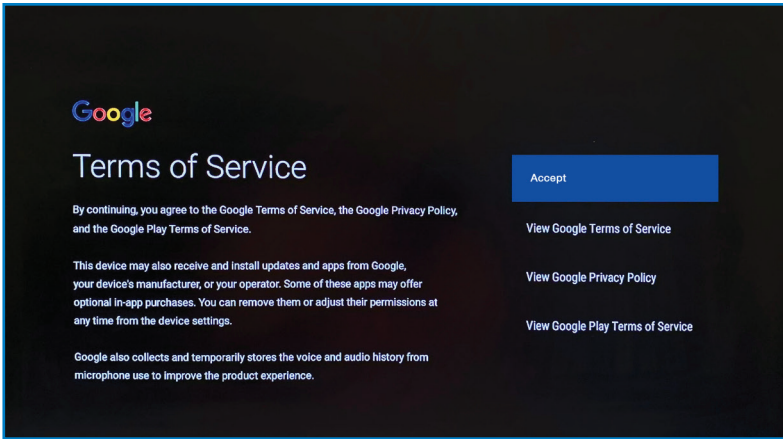

Select **Yes** on the Location screen and press **OK** to continue.

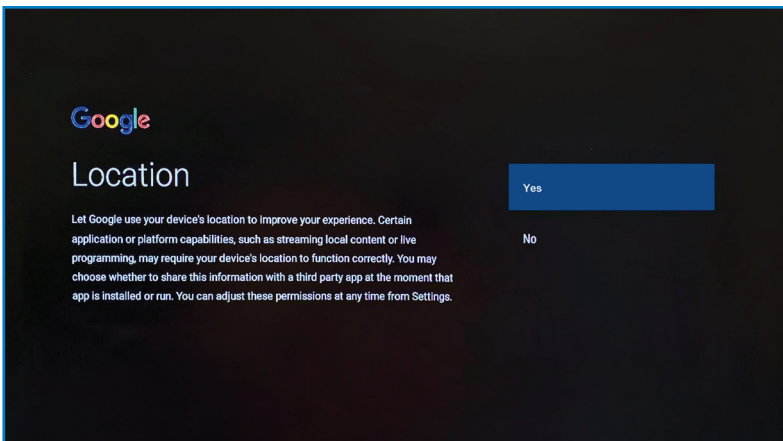

On the Help Improve screen, select **Yes** and press **OK** to continue.

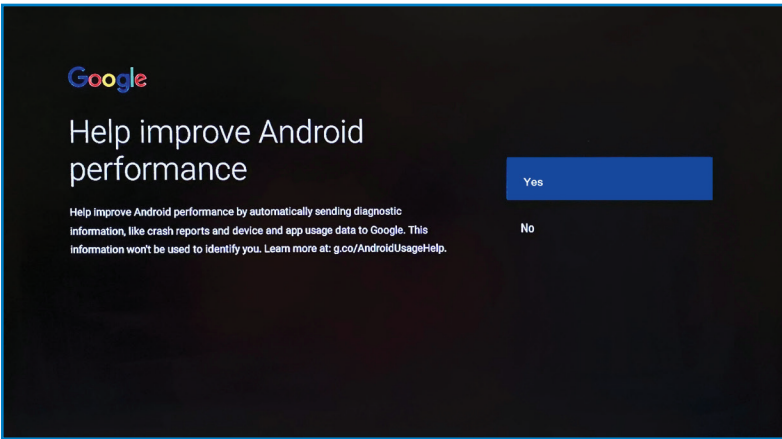

On the Choose a Name screen, select the appropriate name for the unit and press **OK** to continue.

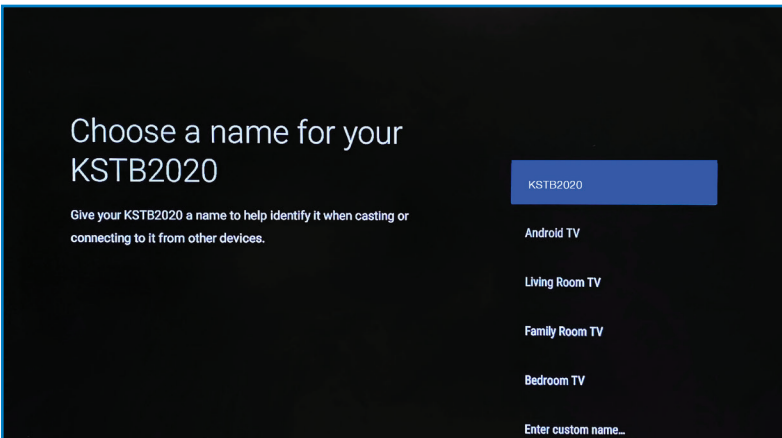

The following Get Started screen will display the login where your Cable Provider App will be located. This app cannot be unselected. Select **Continue** and press **OK** to get to the next screen.

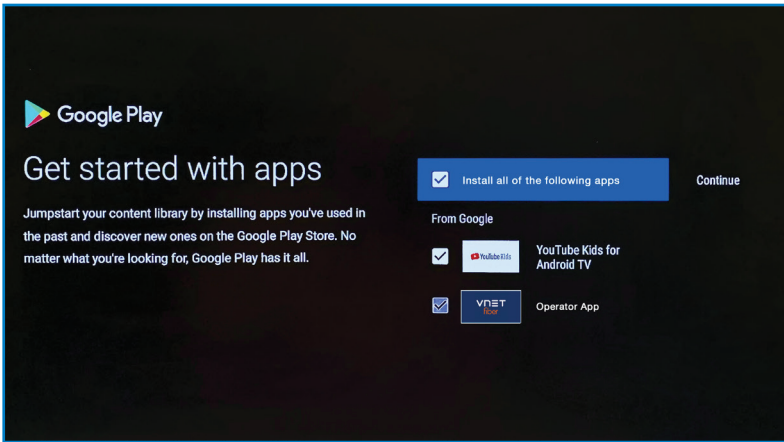

On the Welcome screen, arrow right five times to get to the next screen.

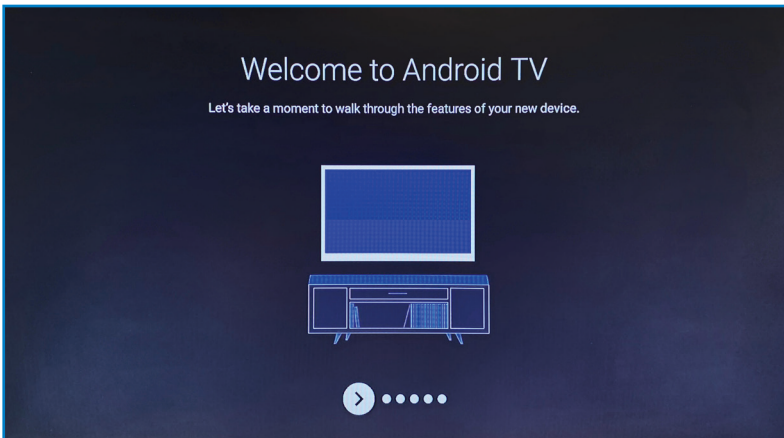

Select **Done** and press **OK** to continue.

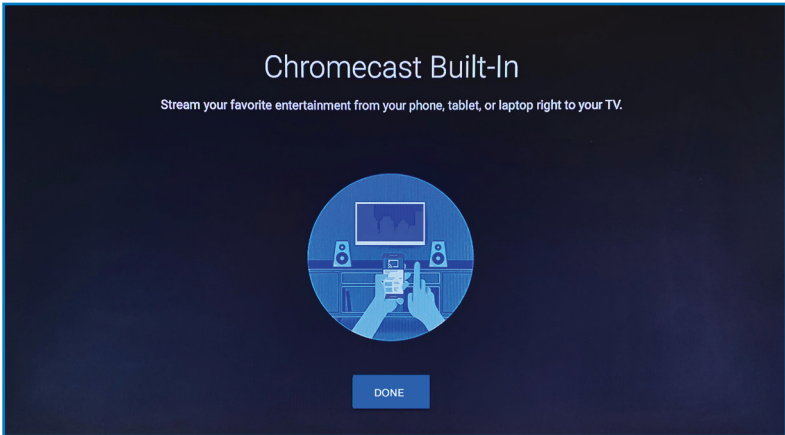

When it is finished processing, the Login screen will be displayed.

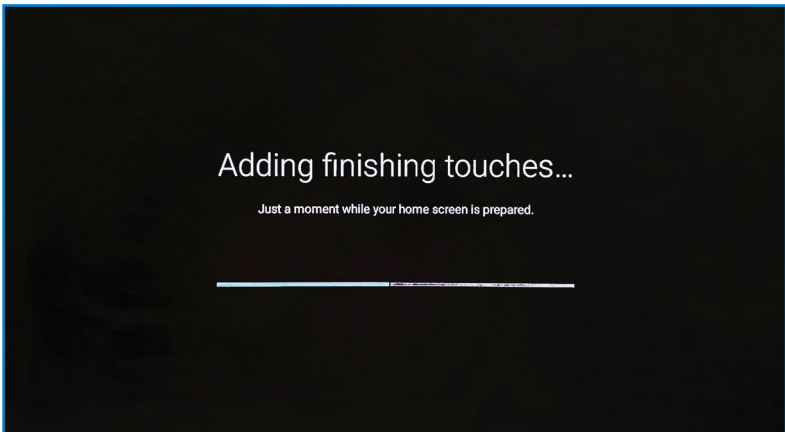

An example login screen is shown. This will be unique for each subscriber. Credentials may be entered using the remote or via a USB keyboard (recommended).

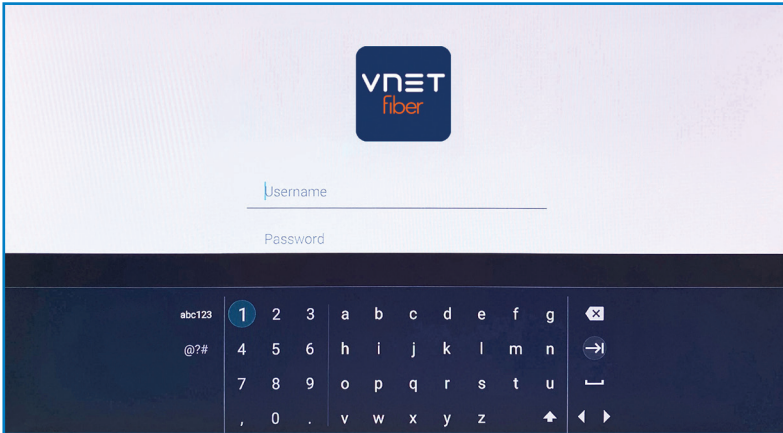

Once logged in, the following screen will be displayed. Select “DETAILS” to be prompted for Wi-Fi network section and sign in. Alternately an Ethernet cable may be connected at this time.

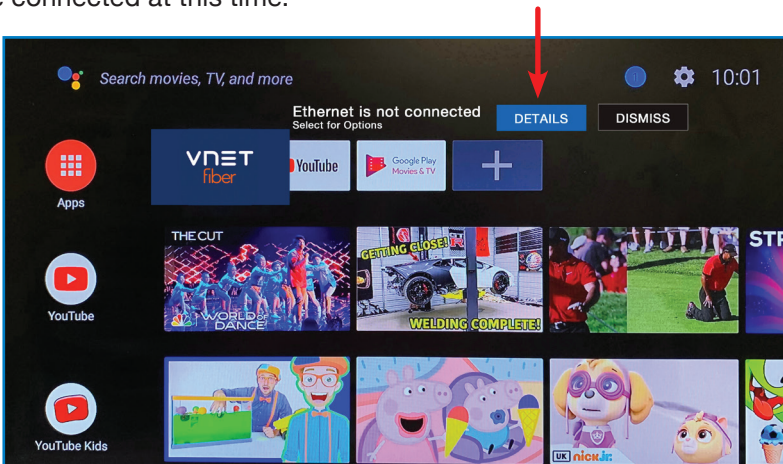

NETWORK SETUP

Wi-Fi Requirements

Wi-Fi networks should be 802.11n or better (802.11AC/AX preferred). The KSTB2020 should be placed in such a fashion that the Wi-Fi signal strength is strong or very strong (as a minimum). To connect the STB to the Wi-Fi network

Wi-Fi connection automatic setup using WPS

Navigate to the Android main menu by pressing the following key sequences:

 Home →  Settings →  Network →  Wi-Fi → Select to enable.

Once Wi-Fi has been enabled, using the remote scroll down and select “Connect via WPS”. Once selected press the WPS button on the home Wi-Fi router. The KSTB2020 will automatically connect to the Wi-Fi network.

Ensure that Wi-Fi network signal strength is strong  or very strong .

If the signal strength is not strong or very strong consider moving the router and STB close to one another if possible. If router/STB repositioning is not feasible Wi-Fi extension, MoCA extension or physical cable connection must be considered. Cables must be CAT-5/5e/6 compliant.

Wi-Fi connection manual setup

Navigate to the Android main menu by pressing the following key sequences:

 Home →  Settings →  Network →  Wi-Fi → Select to enable.

Once Wi-Fi has been enabled, using the remote scroll down and select the required network and press **OK**. When prompted, enter your Wi-Fi password using the remote. Alternately, a USB keyboard may be plugged into the USB port of the KSTB2020. Type password on keyboard as required.

Ensure that Wi-Fi network signal strength is strong  or very strong .

Hard Wired Ethernet Requirements

If the home router is near the Set Top Box location, a CAT-5/5e/6 Ethernet cable may be used for Internet connectivity. Plug one end of the CAT-5/5e/6 cable into the KSTB2020 RJ-45 port. Plug the other end of the cable into any LAN port of the home router.

SERVICE VALIDATION

RCU/STB Operation

Once STB has been installed and credentials have been entered, the user should confirm that remote works as expected with STB. The user should check the following buttons for correct operation.

- Volume up/down
- Channel up/down
- Menu
- Home
- Guide
- Shows
- Movies

General Video Quality

User should validate that overall video quality is as expected. If possible, tune to a channel with fast moving scenes (e.g. football or hockey game).

Signal Strength Validation





Signal strength may be checked via the network sub-menu in the Android main menu.

Using the remote and android menu navigate to the following:

 Home →  Settings →  Network

Ensure that Wi-Fi network signal strength is strong  or very strong .

TROUBLESHOOTING

Observation	Things to Check	Remediation
<p>Video/audio quality is poor on STB or network connection error is displayed.</p>	<p>WiFi signal strength in STB Network connection menu.</p> <p><i>Ideal for consistent video:</i></p> <ul style="list-style-type: none">  Strong WiFi signal  Very Strong WiFi signal <p><i>Video may buffer frequently or will not be consistent:</i></p> <ul style="list-style-type: none">  Weak WiFi signal  Medium WiFi signal 	<p>Relocate router and STB closer in proximity with each other if possible, such that signal is strong or very strong.</p> <p>Connecting the STB to home router with a CAT-5/5e/ cable will also resolve poor WiFi connectivity issues.</p> <p>If video or audio quality is still poor after correcting network, contact VNET Fiber technical support.</p>
	<p>Ethernet cable integrity</p>	<p>If wired Ethernet connectivity is used, reset/replace Ethernet cable as required.</p>
	<p>Router integrity</p>	<p>Power cycle STB and router.</p>
	<p>HDMI/Analog composite cable integrity and connection.</p>	<p>Reset/replace cables as needed.</p>
	<p>TV HDMI port integrity.</p>	<p>Use different TV HDMI port if possible.</p>
	<p>If possible, compare suspect STB A/V quality to another device such as a Blu-ray player.</p>	<p>If the STB is found to show issues while no other devices do, contact VNET Fiber technical support.</p>
<p>Video is not visible on the TV.</p>	<p>HDMI port connection is aligned with the TV's HDMI port selection.</p>	<p>Ensure HDMI port connection and HDMI port selection are the same.</p>
<p>Remote does not control STB, TV, or audio equipment.</p>	<p>Battery charge</p> <p>Remote is not programmed to TV or Audio system.</p> <p>A Remote Control button press always lights up the LED at the top of the remote. Red = an IR command sent. Green = an RF command sent.</p>	<p>Replace batteries if charge is low.</p> <p>Refer to pages 8 or 12 for KURV remote pairing instructions.</p> <p>If NO LED lights on button presses, the batteries should be changed.</p>

APPENDIX A

TV Codes for Remote Pairing

- Top 10 US TV Brands -

TV Maker / Brand	Code Number										
SAMSUNG	10305	10265	10001	10012	10051	10092	10011	10118	10124	10132	10145
	10176	10221	10306	10542	10315	10439	10479	10408	10543		
LG (GOLDSTAR)	10011	10093	10103	10113	10118	10132	10346	10315	10439		
SONY	10043	10075	10117	10130	10067	10170	10238	10247	10309	10409	10452
VIZIO	10011	10315	10351	10530							
PANASONIC	10076	10010	10038	10057	10005	10148	10150	10169	10308	10359	10485
SHARP	10260	10020	10025	10028	10033	10034	10132	10151	10235	10236	10361
	10375	10436	10011								
TOSHIBA	10021	10013	10035	10041	10052	10063	10092	10142	10146	10178	10179
	10393	10303	10464	10419	10517						
DYNEX	10091	10347	10366								
TCL	10256	10371	10267								
SKYWORTH	10522										

TV Maker / Brand	Code Number										
3M	10368										
A MARK	10103	10132	10388								
ACTION	10370										
ADMIRAL	10436	10431									
ADVENT	10135	10339									
ADVENTURA	10372										
AFTRON	10373										
AIKO	10374										
AIWA(R-44A)	10082	10183									
AKAI	10148	10160	10001	10317	10318	10348	10352	10542	10439	10476	10517
ALARON	10376										
ALBATRON	10377										
AMBASSADOR	10378										
AMERICA ACTION	10380										
AMPRO	10070	10164	10249	10381							
AMSTRAD	10053										
ANAM	10045	10055	10057	10076	10095	10099	10103	10109	10112	10143	10380

TV Maker / Brand	Code Number											
AOC	10088	10363	10367	10001	10011	10103	10330	10439				
AOMNI	10354											
APEX	10302	10303	10282									
APEX DIGITAL	10303	10373	10384									
ARCHER	10388											
ASTAR	10390											
AUDIOVOX	10345	10319	10380	10374	10388							
AURORA SYSTEMS	10391											
AVENTURA	10311											
BELCOR	10001	10011	10315									
BELL & HOWELL	10393											
BENQ	10395	10396										
BLAUPUNKT	10084											
BLU: SENS	10476	10455	10499									
BRADFORD	10380											
BRILLIAN	10398											
BROCKWOOD	10011	10315										
BROKSONIC	10143	10166	10174	10431								
BUSH	10399											
BYD: SIGN	10400											
CANDLE	10001	10002	10003	10011	10439	10372	10543					
CANON	10402	10403										
CAPEHART	10059											
CARNIBALE	10001	10439										
CARVER	10415	10405										
CASIO	10406	10407										
CCE	10408											
CELEBRITY	10409											
CELERA	10303											
CETRONIC	10045											
CHANGHONG	10303											
CITIZEN	10001	10002	10003	10011	10045	10092	10094	10132	10439	10374	10372	
		10543	10517									
CLARION	10380											
CLASSIC	10045											
COBY	10412	10011	10275									
COMMERCIAL SOLUTIONS	10413											

TV Maker / Brand	Code Number											
COMPAQ	10414											
CONCERTO	10011	10543										
CONTEC	10041	10045	10051	10052	10380							
CORENA SYSTEM	10301											
CORONADO	10132											
CRAIG	10045	10055	10157	10049	10159	10380	10258					
CROSLEY	10415											
CROWN	10045	10132	10380									
CURTIS MATHES	10001	10092	10011	10132	10365	10413	10415	10393	10319	10436	10542	
	10439	10368	10504	10543	10271							
CXC	10045	10380										
CYBERHOME	10416											
CYTRON	10417	10418										
DAEWOO	10011	10022	10023	10038	10045	10046	10056	10068	10073	10094	10098	
	10102	10105	10108	10111	10114	10116	10118	10119	10127	10132		
	10246	10319	10374	10315	10188							
DAYTRON	10011	10132	10315									
DELL	10148	10314										
DELTA	10419											
DENON	10368	10421										
DIAMOND VISION	10422	10423										
DIGI LINK	10172											
DIGISTAR	10424											
DIGITAL LIFESTYLES	10425	10426										
DIGITAL PROJECTION INC.	10427	10429										
DREAM VISION	10430											
DUMONT	10011											
DURABRAND	10431	10380	10315	10311	10434	10388	10435					
DWIN	10436											
DYNASTY	10045											
DYNATECH	10063											
DYNEX	10091	10347	10366									
EIKI	10253	10402										
ELECTROGRAPH	10354											
ELECTROHOME	10074	10132	10431									
ELECTROBAND	10409											
ELECTROGRAPH	10486	10354										

TV Maker / Brand	Code Number										
ELEMENT	10335	10259	10273	10283							
EMERSON	10001	10012	10013	10029	10033	10045	10048	10049	10051	10052	10091
	10011	10132	10137	10139	10141	10157	10140	10184	10185	10186	10187
	10188	10190	10192	10193	10194	10195	10196	10197	10198	10199	10200
	10201	10202	10355	10393	10319	10431	10380	10315	10311	10505	
EMPREX	10425										
ENVISION	10439	10358	10330								
ENVIXION	10001										
EPSON	10364										
ERAE	10442										
ESA	10317	10318	10311								
FISHER	10013	10058	10393								
FUJITSU	10149	10228	10333	10334	10376						
FUNAI	10033	10045	10380	10311	10376	10452					
FUTURETECH	10045	10380									
GATEWAY	10310	10486									
GE	10001	10014	10015	10038	10057	10070	10083	10011	10121	10133	10141
	10145	10413	10319	10315	10489	10484					
GILBRALTER	10001	10011	10439	10315							
GO VIDEO	10443	10479	10476								
GOODMANS	10445										
GPX	10276										
GRADIENTE	10040										
GRUNDIG	10288	10289									
GRUNPY	10380	10376									
GVA	10278										
H & B	10301										
HAIER	10026	10322	10323	10324	10325	10326	10434	10373	10067		
HALL MARK	10011	10315									
HANNS.G	10447										
HANNSPREE	10448	10449	10447	10263	10264						
HARLEY DAVIDSON	10451	10376	10452								
HARMAN KARDON	10034	10180	10181	10415							
HARVARD	10380	10453									
HAVERMY	10436										
HELIOS	10301										
HELLO KITTY	10319										
HEWLETT PACKARD	10456	10330	10458								

TV Maker / Brand	Code Number										
HISENSE	10266	10011	10279	10280	10373	10459	10462				
HITACHI	10017	10011	10015	10016	10001	10018	10029	10043	10072	10132	10144
	10147	10203	10204	10206	10207	10208	10210	10211	10368	10452	10543
HP	10357										
HUMAX	10143										
HYPERION	10011										
HYUNDAI	10460	10461									
I-INC	10463										
ILO	10091	10343	10362	10356							
INFINITY	10415	10148									
INFOCUS	10464	10364	10466	10467							
INITIAL	10356										
INKEL	10120										
INSIGNIA	10091	10366	10311	10417	10274						
JBL	10148	10415									
JCPENNY	10001	10011	10014	10015	10030	10035	10092	10132	10145		
JENSEN	10019	10234									
JVC	10261	10270	10038	10040	10079	10239	10550				
KAWASHO	10470										
KDS	10335										
KEC	10045	10380									
KENWOOD	10001	10229	10011	10439	10315						
KLEGG	10354										
KLH	10341	10303									
KLOSS	10002	10060	10001	10372							
KMC	10132										
KNOLL SYSTEMS	10467										
KONKA	10473	10475	10476	10477							
KOST	10478	10479									
KREISEN	10480	10479									
KT	10001	10045	10132	10140	10308						
KTV	10380	10439									
LG (GOLDSTAR)	10011	10093	10103	10113	10118	10132	10346	10315	10439		
LLOYD'S	10452										
LODGENET	10069										
LOEWE	10481										
LOGIK	10069										
LUCE	10358	10483									

TV Maker / Brand	Code Number											
LUXMAN	10011	10543										
LXI	10013	10021	10053	10034	10145	10148	10413	10415	10393	10303	10315	
MAGNASONIC	10001	10011	10348									
MAGNAVOX	10001	10003	10011	10060	10061	10062	10064	10065	10066	10086	10088	
	10118	10132	10145	10148	10192	10212	10236	10244	10312	10332	10415	
	10439	10356	10505	10452	10330	10376	10126					
MAGNIN	10484											
MARANTZ	10001	10074	10148	10415	10439							
MATSUI	10148											
MATSUSHITA	10485											
MAXENT	10486	10487										
MB QUART	10315											
MEGATRON	10315	10368	10388	10435								
MEMOREX	10013	10069	10091	10011	10393	10431	10315	10376	10516			
METZ	10084											
MGA	10001	10011	10033	10044	10050	10074	10315	10439	10484			
MIDLAND	10413											
MINERVA	10084											
MINTEK	10356											
MITSUBISHI	10216	10011	10030	10033	10034	10041	10044	10089	10115	10160	10167	
	10168	10214	10001	10245	10436	10315						
MONIVISION	10377											
MONTGOMERY WARD	10185	10217	10218	10219	10220							
MOTOROLA	10436	10335										
MOXELL	10335											
MTC	10001	10011	10439	10315	10543							
MULTITECH	10380											
NAD	10021	10031	10303	10315	10543							
NAKAMICHI	10491											
NAXA	10492											
NEC	10001	10013	10022	10025	10030	10041	10057	10121	10125	10011	10235	
	10439	10315	10543	10405								
NETTV	10486											
NIKEI	10045											
NIKKO	10001	10315	10439	10374								
NIKO	10493											
NOBLEX	10494											
NORCENT	10373	10330	10495	10493								

TV Maker / Brand	Code Number										
NORWOOD MICRO	10362	10498									
NTC	10374										
NUVISION	10502										
OLEVIA	10011	10342	10535	10315							
OLYMPUS	10503										
ONWA	10045	10380									
OPTONICA	10025	10034	10235								
OPTIMUS	10485	10393	10504	10505							
OPTOMA	10506	10448									
OPTONICA	10436										
ORION	10431	10376	10516								
PANASONIC	10076	10010	10038	10057	10005	10148	10150	10169	10308	10359	10485
PENNEY	10001	10011	10413	10303	10315	10439	10484	10489	10388		
PHILCO	10001	10003	10011	10030	10045	10057	10060	10061	10064	10065	10118
	10132	10148	10415	10439	10315						
PHILIPS	10148	10321	10011	10040	10060	10067	10132	10145	10001	10222	10003
	10371	10415	10479								
PILOT	10001	10011	10439	10315							
PIONEER	10504	10024	10029	10031	10032	10011	10248	10254	10304	10001	
POLAROID	10335	10338	10339	10340	10341	10303	10417	10362	10478	10301	10476
PORTLAND	10011	10132	10374	10315	10335	10424	10476				
PROSCAN	10133	10249	10413	10262	10257	10268	10067	10269			
PROTON	10059	10011	10103	10132	10165	10251	10315	10388			
PROTRON	10507	10508									
PROVIEW	10335										
PULSAR	10011	10315									
PUNEET	10425										
PVISION	10442										
QUASAR	10038	10057	10243	10308	10485						
RADIO SHACK	10025	10045	10048	10011	10118	10132	10001	10235			
RCA	10001	10004	10006	10011	10029	10030	10057	10083	10133	10145	10161
	10171	10232	10371	10413	10484	10315	10256	10272			
REALISTIC	10013	10025	10045	10048	10001	10011	10235	10393	10380	10315	10439
	10543										
REVOLUTION HD	10354										
ROCTEC	10237										
RUNCO	10152	10153	10001	10250	10252	10336	10337	10439			
SAMPO	10001	10059	10011	10486	10439						

TV Maker / Brand	Code Number										
SAMSUNG	10305	10265	10001	10012	10051	10092	10011	10118	10124	10132	10145
	10176	10221	10306	10542	10315	10439	10479	10408	10543		
SANSUI	10431	10452	10516	10517							
SANYO	10013	10026	10027	10037	10041	10054	10058	10078	10253	10393	10402
	10484										
SCEPTRE	10313	10067									
SCIMITSU	10011	10315									
SCOTT	10033	10045	10049	10011	10132	10380	10315	10376			
SCOTCH	10315										
SEARS	10011	10013	10021	10033	10035	10058	10078	10092	10132	10145	10244
	10413	10415	10393	10303	10315	10311	10543	10376	10452		
SEIKI	10259	10283	10284	10285	10286	10287					
SELECO	10368	10430									
SHARP	10260	10020	10025	10028	10033	10034	10132	10151	10235	10236	10361
	10375	10436	10011								
SHARPER IMAGE	10518										
SHERWOOD	10120										
SHOGUN	10011	10315									
SIEMENS	10084										
SIGNATURE	10069	10011									
SIGNATURE 2000	10011										
SIGNET	10519	10478	10520								
SIM2 MULTIMEDIA	10430										
SIMPSON	10001										
SKYWORTH	10522										
SOLARISM	10523										
SOLE	10358	10483	10301	10479	10354						
SONY	10043	10075	10117	10130	10067	10170	10238	10247	10309	10409	10452
SOUNDESIGN	10003	10033	10045	10011	10380	10315	10376				
SOVA	10507										
SOYO	10425	10463	10524	10525	10476						
SPECTRICON	10103	10011	10388								
SPECTRONIQ	10335										
SQUAREVIEW	10311										
SSS	10011	10045	10380	10315							
STARLITE	10011	10380									
STUDIO EXPERIENCE	10377										
SUNBRITE	10528	10529									

TV Maker / Brand	Code Number										
SUPERSCAN	10436	10530									
SUPRE MACY	10002	10372									
SUPREME	10409										
SVA	10373	10479	10301	10532	10533						
SYLVANIA	10001	10003	10008	10011	10060	10061	10064	10118	10126	10065	10145
	10148	10155	10311	10355	10415	10439					
SYMPHONIC	10380	10311	10452	10505							
SYNTAX	10342	10535	10315								
TANDY	10034	10436									
TASHIKO	10537										
TATUNG	10057	10063	10388	10458	10362						
TCL	10256	10371	10267								
TEAC	10379	10281									
TECHNICS	10080	10076	10485								
TECHNOL ACE	10376										
TECHVIEW	10539	10541									
TECHWOOD	10011	10388	10543								
TELEMAGIC	10402										
TEKNIKA	10001	10002	10003	10011	10030	10033	10036	10045	10069	10074	10092
	10094	10132	10415	10380	10374	10315	10543	10376			
TELEFUNKEN	10039	10047	10241	10242	10542	10543	10544				
TELERENT	10069										
TERA	10156										
THOMAS	10452										
TMK	10011	10315	10543	10378							
TOSHIBA	10021	10013	10035	10041	10052	10063	10092	10142	10146	10178	10179
	10393	10303	10464	10419	10517						
TOTEVISION	10132										
TRUTECH	10353										
TVS	10431										
ULTRA	10547	10508									
UNIVERSAL	10014	10015									
UPSTAR	10277										
US LOGIC	10362										
VECTOR RESEARCH	10001	10439									
VENTURER	10315										
VICTOR	10550										
VIDEO CONCEPTS	10160										

TV Maker / Brand	Code Number										
VIDIKRON	10255	10415									
VIDTECH	10011	10315									
VIEWSONIC	10363	10088	10330	10331	10349	10486	10530	10503			
VIKING	10372										
VIORE	10316										
VISART	10551										
VITO	10360										
VIZIO	10011	10315	10351	10530							
WARDS	10011	10014	10015	10025	10033	10061	10062	10064	10065	10069	10071
	10132	10148	10001	10235	10415	10315	10439	10489	10543	10376	
WAYCON	10303										
WHITE WESTING HOUSE	10091	10319	10320	10327	10328	10329	10067	10431	10409		
WINBOOK	10362										
WOYOUNG	10307										
WYSE	10330										
XOCECO	10552										
YAMAHA	10001	10011	10439	10315							
YORK	10011										
ZENITH	10009	10069	10070	10090	10094	10431	10315	10374	10452	10516	
ZONDA	10103	10388									

APPENDIX B

Audio System Codes for Remote Pairing

Audio Maker / Brand	Code Number										
ADCOM	20088	20098	20218	20147	20233						
AIWA	20142	20182	20025	20141	20022	20110					
AKAI	20128										
ANAM	20026	20188	20189								
ANTHEM	20004										
B&K	20102	20103									
BOSE	20007	20185	20131								
CARVER	20253	20013	20037	20060	20068	20148	20221	20226	20245	20250	20015
CLARION	20132										
COBY	20010	20017									
DENON	20041	20234	20111	20149	20150	20152	20232	20003			
ENLIGHTENED	20105										
EVERQUEST	20032										
FISHER	20037	20015	20083	20207							
FOSGATE AUDIONIC	20153										
HAIER	20019	20023									
HARMAN KARDON	20205	20208	20153	20228	20229	20249					
HITACHI	20035	20040	20027	20202							
ILIVE	20049	20050									
INKEL	20012										
INSIGNIA	20061										
JCPENNY	20016	20108									
JENSEN	20065										
JVC	20112										
KENWOOD	20012	20206	20231	20033	20015	20211	20212	20213	20214	20215	20222
	20230	20134	20246								
LEXICON	20125	20156	20158	20159							

Audio Maker / Brand	Code Number											
LG (GOLDSTAR)	20069	20077	20018	20192								
LOTTE	20191	20193										
LUXMAM	20042											
LXI	20084											
MAGNAVOX	20013	20092										
MARANTZ	20013	20093	20047	20072	20063	20203	20221	20250				
MAXELL	20078											
MCINTOSH	20160											
MCS	20016											
MITSUBISHI	20164	20165										
NAD	20036											
NAKAMICHI	20167	20047										
NILES	20168											
ONKYO	20178	20053	20113	20114	20024	20177	20179	20223	20224	20251		
OPTIMUS	20029	20033	20048									
OUTLAW	20183											
PANASONIC	20126	20014	20039	20094	20194	20200						
PARASOUND	20254											
PHILIPS	20009	20301	20302	20303	20093	20013	20172	20124				
PIONEER	20082	20021	20046	20051	20057	20073	20076	20096	20001	20054	20237	
	20238	20239	20240	20241	20242	20243	20244					
PROCEED	20006	20248	20252									
QUASAR	20014	20094										
RCA	20062	20106	20120	20138	20056	20123						
REALISTIC	20011	20030	20084	20002	20026	20101						
ROTEL	20089	20080	20091									
SAMSUNG	20304	20197	20198	20199	20306							
SANSUI	20116	20013	20124	20047								
SANYO	20187											
SCOTT	20026	20097										
SHARP	20139	20058	20033	20100	20132	20133	20134	20127				
SHERWOOD	20045	20031	20247									

Audio Maker / Brand	Code Number										
	20008	20176	20005	20025	20107	20145	20090	20170	20195	20209	20216
SONY	20008	20176	20005	20025	20107	20145	20090	20170	20195	20209	20216
	20305										
SOUNDESIGN	20043										
SSI	20075										
TAEKWANG	20128	20186	20195								
TEAC	20066	20067	20026	20190							
TECHNICS	20126	20094	20109	20014	20137						
THOMSON	20217										
TOSHIBA	20155	20118	20237	20255							
VICTOR	20020	20112									
VIZIO	20180										
WARDS	20015										
YAMAHA	20140	20166	20201	20028	20033	20038	20074	20132	20175	20204	20210
	20219	20220	20227	20235	20236						
ZANTEK	20174										

